

Timing Solutions for AMD® FPGAs

Skyworks provides a broad portfolio of frequency flexible timing products that enable hardware designers to simplify clock generation, clock distribution, jitter attenuation and network synchronization. The portfolio includes:

- Network synchronizers
- Jitter-attenuating clocks
- Clock generators
- Clock buffers
- PCIe clocks and buffers
- Oscillators (XO and VCXO)





Skyworks clocks leverage proprietary DSPLL® and MultiSynth™ technologies to produce any frequency combination with ultra-low jitter, enabling best-in-class clock tree integration. NetSync™ clocks provide SyncE compliant operation along with software adjustment of output frequency and phase for IEEE 1588 applications, while delivering ultra low jitter outputs that eliminate the need for a separate jitter attenuator device.

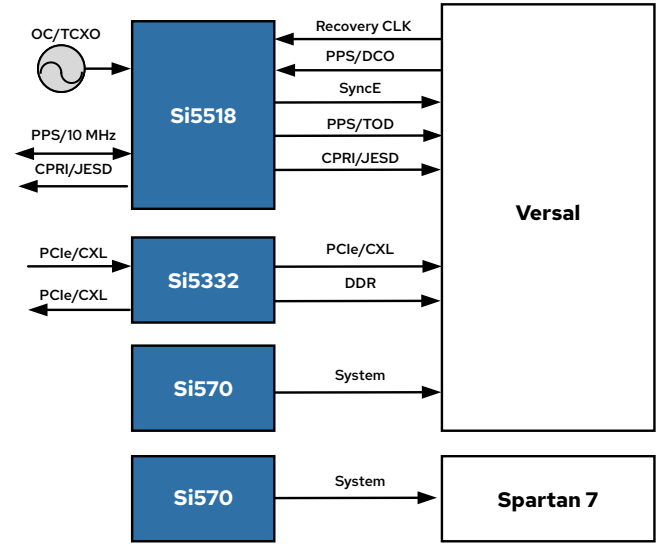

Clock buffers provide low-jitter, low-skew distribution with integrated format and voltage level translation. PCIe clocks and buffers support Gen 4, Gen 5, Gen 6, and Gen 7 requirements and include on-chip termination to streamline board design. XO and VCXO products are factory-configurable to any frequency, with samples typically available within one to two weeks.

For more information related to reference designs or partner pricing, please contact your local Skyworks sales representative.



 <p>Clock Generators, Jitter Attenuating Clocks</p>	  <p>AccuTime</p> <p>Network Synchronizers</p>	 <p>Clock Generators</p>	 <p>Oscillators, VCXOs</p>
<ul style="list-style-type: none"> • Up to 18 outputs • Any frequencies and formats • < 50 fs RMS jitter 	<ul style="list-style-type: none"> • Supports SyncE and PTP • < 50 fs RMS jitter • Optional AccuTime™ IEEE 1588 software 	<ul style="list-style-type: none"> • Any format input-to-output translation • <50 fs additive RMS phase jitter • LVDS, 800 mV LVDS, LVPECL, HCSL, LVCMOS outputs 	<ul style="list-style-type: none"> • Any-frequency, 200 kHz to 1.5 GHz • On-chip LDOs deliver high PSRR • I²C programmable

Recommended Timing Solutions for AMD® FPGAs

AMD FPGA	Skyworks			
	Network Synchronizer	Clock Generator/Jitter Attenuator Clock	Clock Buffer	Oscillator
Versal™ AI Edge Versal Core	Si5403	Si5332	Si53340	Si570
Versal Premium Series Versal Prime Series	Si5403	Si5332	Si53340 Si53306	Si570
Zynq™ UltraScale+™ RFSoc	Si5518	Si5381/2 Si5341	Si53340	Si570
Zynq UltraScale+ MPSoC	Si5403	Si5328 Si5324 Si5341	Si53340	Si570
Zynq 7000 Series				Si570
Virtex™ UltraScale+™ Virtex UltraScale		Si5348 Si5328 Si5335	Si53340 Si53301/6	Si570
Kintex™ UltraScale+™ Kintex UltraScale		Si5328 Si5335	Si53340	Si570
Virtex 7 Kintex™ 7 Spartan™ 7 Artix™ 7		Si5324		Si570

FPGA Phase Noise Mask Requirements and Skyworks Timing Solutions

Virtex, Kintex, Zync UltraScale/+ GTH Transceiver		XO		VCXO		Clock Buffer		Clock Generator				Jitter Attenuating Clock		Network Synchronizer			Wireless Synchronizer			
Offset Frequency	Phase Noise (dBc/Hz at 156.25 MHz)	Si545-9	Si540-4	Si570 Si53x	Si56x	Si55x	SKY531xx	Si533xx	Si5360 SKY62101	Si5391	Si5341 Si5340	Si5332	SKY63101-3	Si536x SKY63103-5	Si539x	SKY69110 SKY69120/2	SKY69101	Si540x SKY69102	SKY69001/2	Si55xx SKY69003
10 kHz	-111	-140	-132	-128	-130	-128	-152	-140	-143	-139	-136	-126	-144	-143	-136	-143	-144	-143	-144	-143
100 kHz	-130	-145	-139	-135	-141	-133	-161	-150	-148	-145	-141	-132	-150	-148	-145	-148	-150	-148	-150	-148
1 MHz	-136	-152	-151	-144	-150	-144	-165	-154	-154	-151	-150	-154	-156	-154	-151	-154	-156	-154	-156	-154
10 MHz	-	-162	-160	-156	-159	-147	-166	-155	-167	-165	-164	-158	-167	-167	-165	-167	-167	-167	-167	-167

Virtex, Kintex, Zync UltraScale/+, Versal GTY Transceiver		XO		VCXO		Clock Buffer		Clock Generator				Jitter Attenuating Clock		Network Synchronizer			Wireless Synchronizer	
Offset Frequency	Phase Noise (dBc/Hz at 156.25 MHz)	Si545-9	Si540-4	Si56x	SKY531xx	Si5330x	Si5360 SKY62101	Si5391	Si5341 Si5340	Si5332	SKY63101-3	Si536x SKY63103-5	Si539x	SKY69110 SKY69120/2	SKY69101	Si540x SKY69102	SKY69001/2	Si55xx SKY69003
10 kHz	-112	-140	-132	-130	-152	-140	-143	-139	-136	-126	-144	-143	-136	-143	-144	-143	-144	-143
100 kHz	-128	-145	-139	-141	-161	-150	-148	-145	-141	-132	-150	-148	-145	-148	-150	-148	-150	-148
1 MHz	-145	-152	-151	-150	-165	-154	-154	-151	-150	-154	-156	-154	-151	-154	-156	-154	-156	-154
10 MHz	-	-162	-160	-159	-166	-155	-167	-165	-164	-158	-167	-167	-165	-167	-167	-167	-167	-167

Virtex, Kintex UltraScale+, Versal GTM Transceiver		XO		VCXO		Clock Buffer		Clock Generator				Jitter Attenuating Clock		Network Synchronizer			Wireless Synchronizer	
Offset Frequency	Phase Noise (dBc/Hz at 156.25 MHz)	Si545-9	Si540-4	Si56x	SKY531xx	Si533xx	Si5360 SKY62101	Si5391	Si5341 Si5340	Si5332	SKY63101-3	Si536x SKY63103-5	Si539x	SKY69110 SKY69120/2	SKY69101	Si540x SKY69102	SKY69001/2	Si55xx SKY69003
10 kHz	-112	-140	-132	-130	-152	-140	-143	-139	-136	-126	-144	-143	-136	-143	-144	-143	-144	-143
100 kHz	-128	-145	-139	-141	-161	-150	-148	-145	-141	-132	-150	-148	-145	-148	-150	-148	-150	-148
1 MHz	-145	-152	-151	-150	-165	-154	-154	-151	-150	-154	-156	-154	-151	-154	-156	-154	-156	-154
10 MHz	-	-162	-160	-159	-166	-155	-167	-165	-164	-158	-167	-167	-165	-167	-167	-167	-167	-167

FPGA Phase Noise Mask Requirements and Skyworks Timing Solutions

Virtex, Kintex UltraScale+, Versal GTM Transceiver		XO		VCXO		Clock Buffer		Clock Generator				Jitter Attenuating Clock			Network Synchronizer			Wireless Synchronizer	
Offset Frequency	Phase Noise (dBc/Hz at 156.25 MHz)	Si545-9	Si540-4	Si56x	Si55x	SKY531xx	Si533xx	Si5360 SKY62101	Si5391	Si5341 Si5340	Si5332	SKY63101-3	Si536x SKY63103-5	Si539x	SKY69110 SKY69120/2	SKY69101	Si540x SKY69102	SKY69001/2	Si55xx SKY69003
10 kHz	-111	-140	-132	-130	-128	-152	-140	-143	-139	-136	-126	-144	-143	-136	-143	-144	-143	-144	-143
100 kHz	-130	-145	-139	-141	-133	-161	-150	-148	-145	-141	-132	-150	-148	-145	-148	-150	-148	-150	-148
1 MHz	-136	-152	-151	-150	-144	-165	-154	-154	-151	-150	-154	-156	-154	-151	-154	-156	-154	-156	-154
10 MHz	-	-162	-160	-159	-147	-166	-155	-167	-165	-164	-158	-167	-167	-165	-167	-167	-167	-167	-167

Tools and Support



[ClockBuilder Pro](#)



[PCIe Clock Jitter Tool](#)



[IEEE 1588 Software](#)



[Reference Manuals](#)



[Evaluation Boards](#)

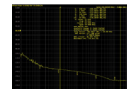

[Technical Support Center](#)

For more information, visit www.skyworksinc.com/products/timing.