

DATA SHEET

CLA4603-085LF: Surface-Mount Limiter Diode

Applications

- Low-loss, high-power limiters
- Receiver protectors

Features

- Low thermal resistance: 96 °C/W
- Typical threshold level: +9 dBm
- Low capacitance: 0.33 pF
- Low-profile, ultra-miniature QFN (3-pin, 2 x 2 mm) package (MSL1, 260 °C per JEDEC J-STD-020)
- For RoHS and other product compliance information, see the [Skyworks Certificate of Conformance](#)

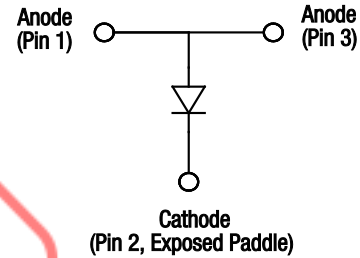
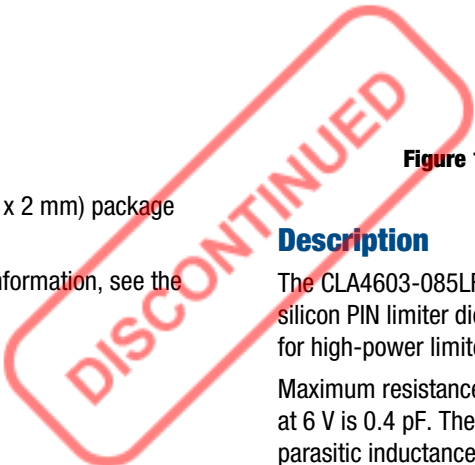

Figure 1. CLA4603-085LF Block Diagram

Description

The CLA4603-085LF is a surface-mountable, low-capacitance silicon PIN limiter diode designed as a shunt connected PIN diode for high-power limiter applications from 10 MHz to over 10 GHz.

Maximum resistance at 10 mA is 2 Ω and maximum capacitance at 6 V is 0.4 pF. The combination of low junction capacitance, low parasitic inductance, low thermal resistance, and nominal 1.5 μm I-region width, makes the CLA4603-085LF useful in large signal limiter applications. The threshold level is +9 dBm, nominal.

A block diagram of the CLA4603-085LF is shown in Figure 1. The absolute maximum ratings of the CLA4603-085LF are provided in Table 1. Electrical specifications are provided in Table 2.

Typical performance characteristics of the CLA4603-085LF are provided in Table 3 and illustrated in Figures 4, 5, 6, and 7.

Table 1. CLA4603-085LF Absolute Maximum Ratings¹

Parameter	Symbol	Minimum	Maximum	Units
Reverse voltage	V _R		45	V
Forward current @ 25 °C	I _F		1.5	A
CW power dissipation @ 85 °C	P _D		1	W
Peak pulse power dissipation @ 85 °C (10% duty cycle)			10	W
Storage temperature	T _{STG}	-65	+200	°C
Junction temperature	T _J		175	°C
Operating temperature	T _A	-55	+150	°C
Electrostatic discharge:	ESD			
Charged Device Model (CDM), Class 4			1000	V
Human Body Model (HBM), Class 1C			1000	V
Machine Model (MM), Class B			150	V

¹ Exposure to maximum rating conditions for extended periods may reduce device reliability. There is no damage to device with only one parameter set at the limit and all other parameters set at or below their nominal value. Exceeding any of the limits listed here may result in permanent damage to the device.

ESD HANDLING: Although this device is designed to be as robust as possible, electrostatic discharge (ESD) can damage this device. This device must be protected at all times from ESD when handling or transporting. Static charges may easily produce potentials of several kilovolts on the human body or equipment, which can discharge without detection. Industry-standard ESD handling precautions should be used at all times.

Table 2. CLA4603-085LF Electrical Specifications¹
(T_A = +25 °C Unless Otherwise Noted)

Parameter	Symbol	Test Condition	Min	Typ	Max	Units
Breakdown voltage	V _B	I _R = 10 μA	20		45	V
Reverse current	I _R	V _R = 16 V			1	μA
Capacitance	C _T	f = 1 MHz, V _R = 6 V		0.33	0.40	pF
Series resistance	R _S	f = 500 MHz, I _F = 10 mA		1.7	2.0	Ω
Series inductance	L _S			0.3		nH
Carrier lifetime	T _L	I _F = 10 mA		10		ns
I region width	W			1.5		μm
CW thermal resistance	θ _{JC}	Junction-to-case		96		°C/W
Peak thermal resistance	θ _P	Single 1 μs pulse width, junction-to-case (0.01% duty cycle)		0.39		°C/W

¹ Performance is guaranteed only under the conditions listed in this table.

Table 3. Typical Performance @ 25 °C

Part Number	Insertion Loss @ -10 dBm (dB)	Input Power for 1 dB Loss (dBm)	Maximum Pulsed Input Power (dBm)	Output @ Maximum Pulsed Input (dBm)	Maximum CW Input power (W)	Recovery Time (ns)
CLA4603-085LF	0.1	+9	+65	+35	3	10

Notes:

Limiter power results @ 1 GHz for shunt connected, single limiter diode and DC return in 50 Ω line.

Pulsed power measurements taken at 1 us pulse width, pulse frequency = 10 kHz, and 0.01% duty cycle.

Maximum CW input power @ 25 °C heat sink. Derate linearly to 0 W @ 175 °C.

Recovery time represents the transition time from the high-loss state to the low-loss state following the removal of a high-power input. It is defined as the time from the end of the high-power pulse to the time when insertion loss has returned to within 3 dB of the quiescent (low-power) state.

Functional Description

The PIN limiter diode can be described as an incident power controlled, RF variable resistor. When there is no large input signal present, the impedance of the limiter diode is at its maximum, which produces minimum insertion loss, typically less than 0.1 dB. The presence of a large input signal temporarily forces the impedance of the diode to a much lower value, which produces an impedance mismatch that reflects the majority of the input signal power back towards its source.

During the limiting process, a DC current is generated by the PIN limiter diode. The current is not the result of rectification, but is the result of charge carriers being forced into the I layer by the forward alternations of the large input signal. A complete path must be provided for this current or the diode is not capable of limiting. Therefore, an RF choke or similar structure must be provided to complete the path for DC current flow.

The DC block capacitors shown in Figure 2 are optional; they protect the limiter diode from external DC voltage that may be present in the source or load circuits.

A cross section of the suggested printed circuit board design is shown in Figure 3. The via shown in this view is critical, both for electrical performance and for thermal performance. It is recommended that several vias should be placed under the entire footprint of the exposed paddle (pin 2) to minimize both electrical inductance to the system ground and thermal resistance to the system heat sink.

For more information about the operation of limiter diodes, refer to the Skyworks Application Note, *PIN Limiter Diodes in Receiver Protectors*, document number 200480.

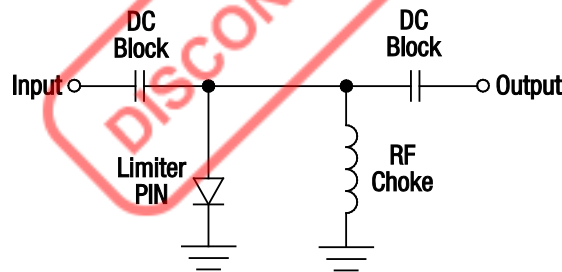

Figure 2. Single Stage Limiter Circuit

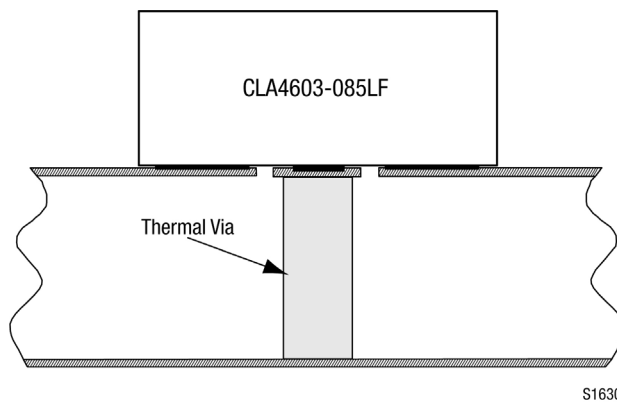

Figure 3. Cross-Sectional View of Suggested Printed Circuit Board

Typical Performance Characteristics
(TA = 25 °C, Unless Otherwise Noted)

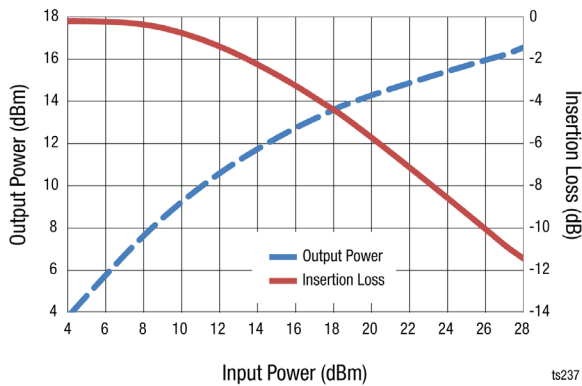

Figure 4. Output Power and Insertion Loss vs Input Power (f = 1.0 GHz, Board Loss Included)

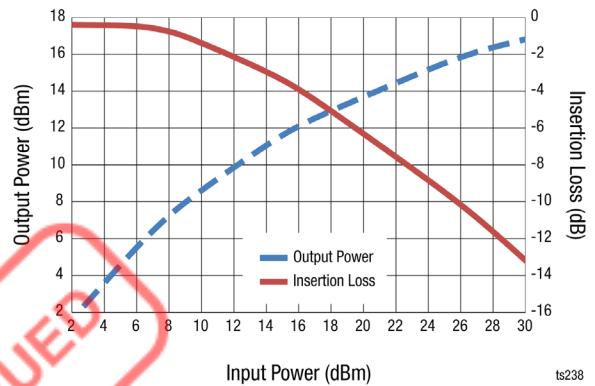

Figure 5. Output Power and Insertion Loss vs Input Power (f = 2.6 GHz, Board Loss Included)

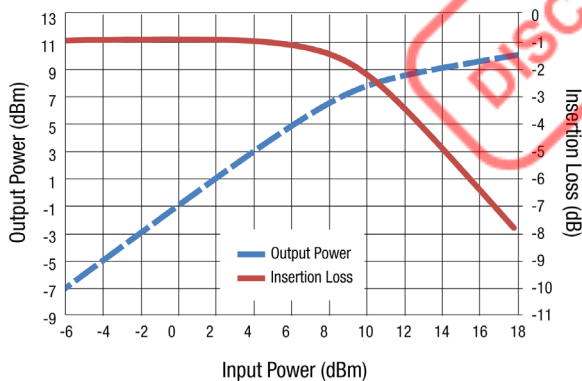

Figure 6. Output Power and Insertion Loss vs Input Power (f = 10 GHz, Board Loss Included)

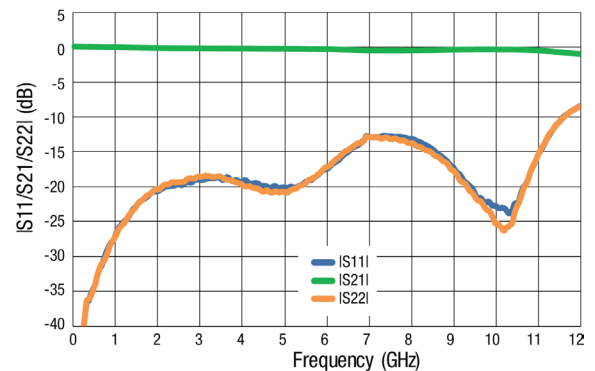

Figure 7. S-Parameters vs Frequency (Shunt to GND Limiter Only)

High-Power Limiter Design Application

The CLA4603-085LF PIN limiter diode is designed for shunt applications in receiver protection power limiter circuits. Compared to other surface mount packages, the design of the QFN package produces lower thermal resistance and also reduces the effects of the parasitic inductance of the anode bond wires.

A cross-sectional view of the CLA4603-085LF PIN limiter diode is shown in Figure 8. The cathode of the die is soldered directly to the top of the exposed paddle. This paddle is composed of copper, so its thermal resistance is very low.

The copper ground paddle minimizes the total thermal resistance between the I layer, which is the location where most heat is generated under normal operation, and the surface to which the package is mounted. Minimal thermal resistance between the I layer and the external environment minimizes junction temperature.

The electrically equivalent circuit of the CLA4603-085LF PIN limiter diode is shown in Figure 9. The inductances of pins 1 and 2, as well as the inductances of the bond wires are in series with the input and output transmission lines of the external circuit rather than the portion of the circuit that contains the shunt PIN limiter diode.

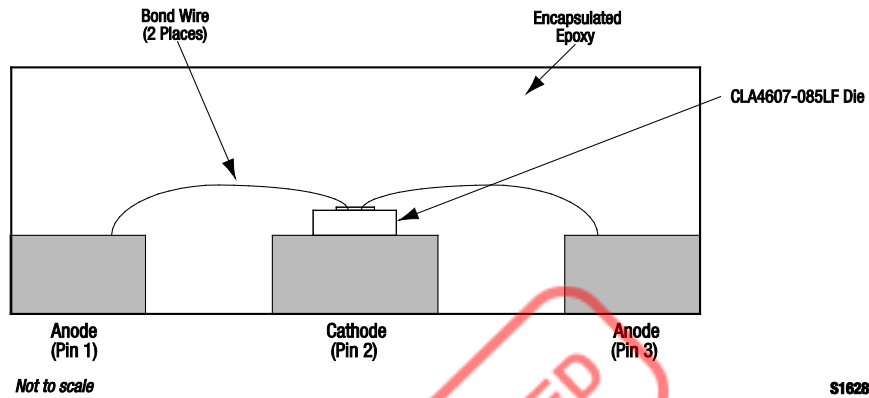

Figure 8. Cross-Sectional View of the CLA4603-085LF

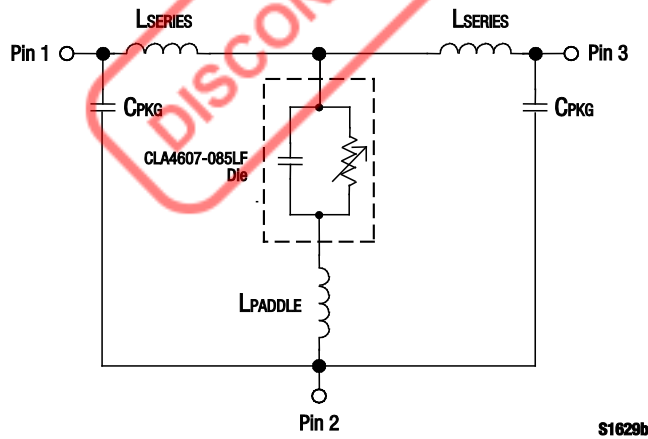

Figure 9. CLA4603-085LF Electrically Equivalent Circuit

Package Dimensions

The PCB layout footprint for the CLA4603-085LF is shown in Figure 10. Typical part markings are shown in Figure 11. Package dimensions are provided in Figure 12, and Figure 13 provides the tape and reel dimensions.

Package and Handling Information

Instructions on the shipping container label regarding exposure to moisture after the container seal is broken must be followed. Otherwise, problems related to moisture absorption may occur when the part is subjected to high temperature during solder assembly.

The CLA4603-085LF is rated to Moisture Sensitivity Level 1 (MSL1) at 260 °C. It can be used for lead or lead-free soldering. For additional information, refer to the Skyworks Application Note, *Solder Reflow Information*, document number 200164.

Care must be taken when attaching this product, whether it is done manually or in a production solder reflow environment. Production quantities of this product are shipped in a standard tape and reel format.

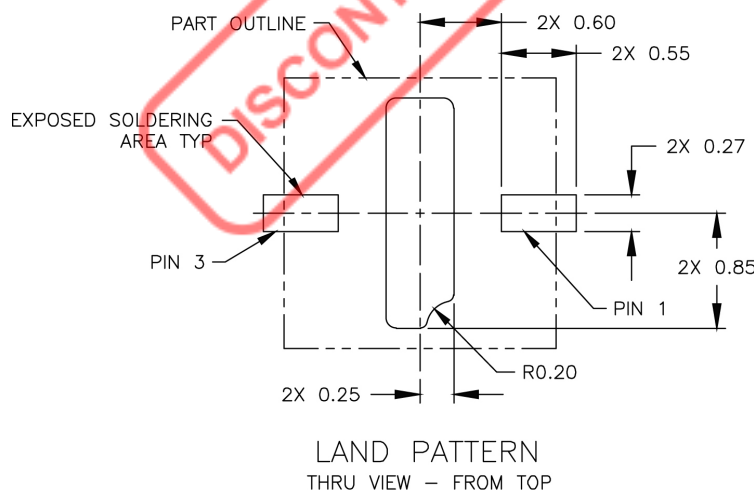

Figure 10. CLA4603-085LF PCB Layout Footprint

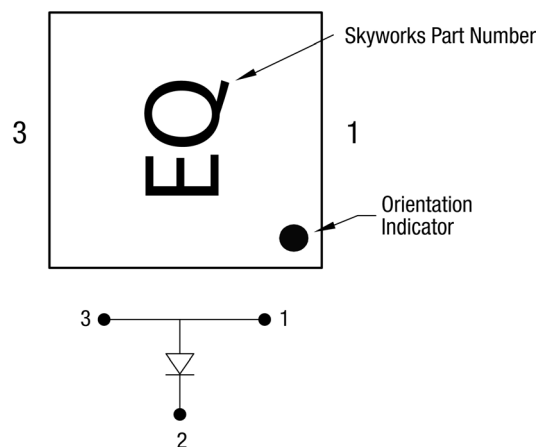
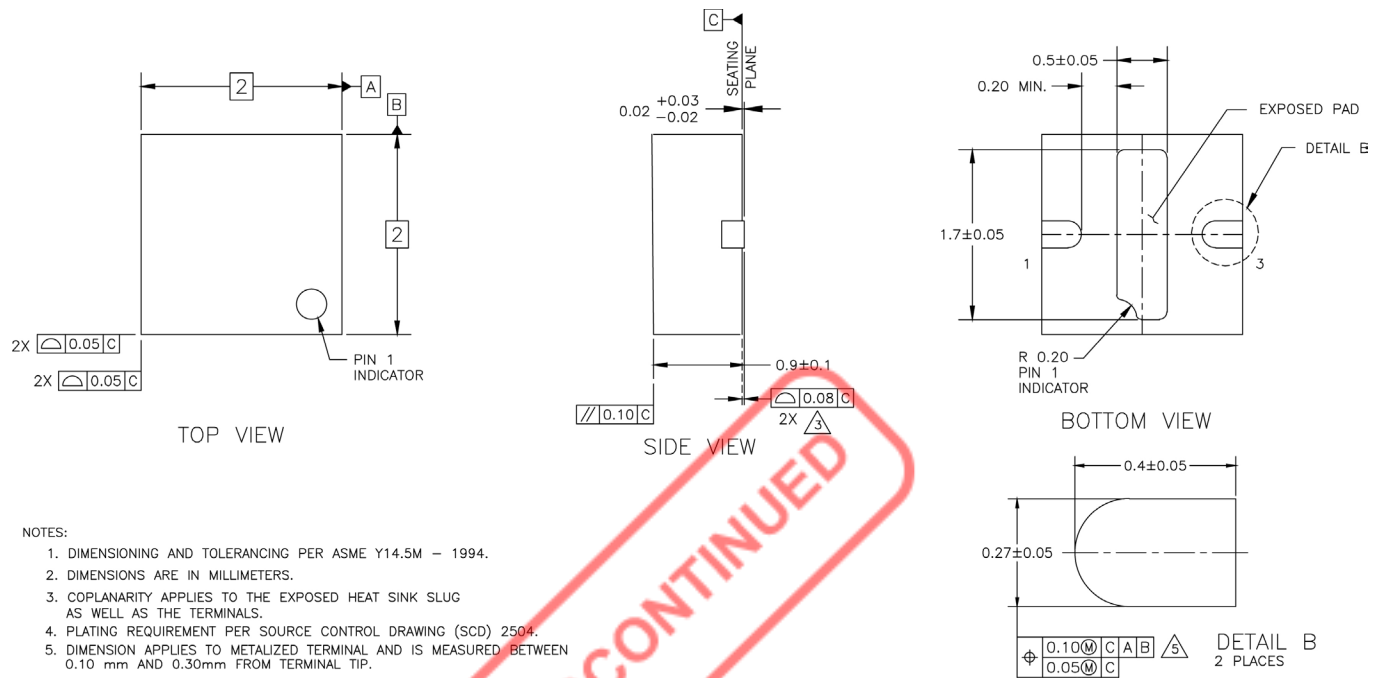

Figure 11. Typical Part Markings (Top View)

DATA SHEET • CLA4603-085LF: Surface-Mount Limiter Diode



DISCONTINUED

Figure 12. CLA4603-085LF Package Dimensions

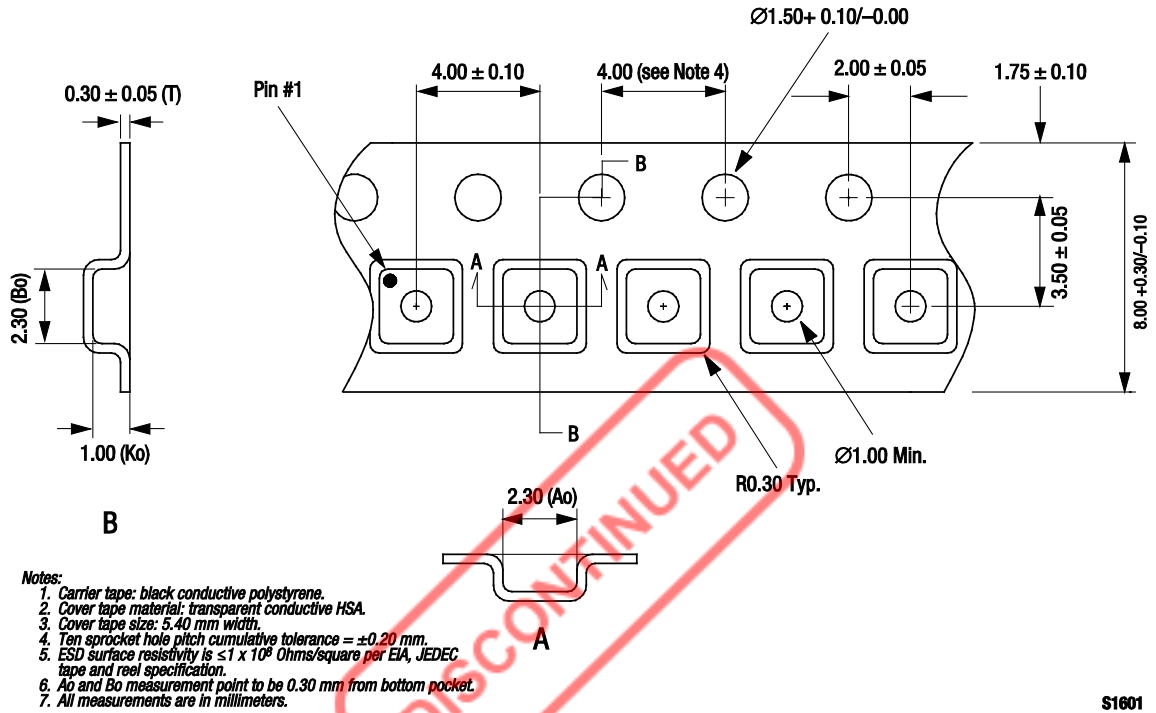

S1601

Figure 13. CLA4603-085LF Tape and Reel Dimensions

Ordering Information

Part Number	Product Description	Evaluation Board Part Number
CLA4603-085LF	Surface-Mount Limiter Diode	CLA4603-085LF-EK1



Copyright © 2011-2014, 2019-2020, 2026, Skyworks Solutions, Inc. All Rights Reserved.

Information in this document is provided in connection with Skyworks Solutions, Inc., and its subsidiaries (“Skyworks”) products or services. These materials, including the information contained herein, are provided by Skyworks as a service to its customers and may be used for informational purposes only by the customer. Skyworks assumes no responsibility for errors or omissions in these materials or the information contained herein. Skyworks may change its documentation, products, services, specifications or product descriptions at any time, without notice. Skyworks makes no commitment to update the materials or information and shall have no responsibility whatsoever for conflicts, incompatibilities, or other difficulties arising from any future changes.

No license, whether express, implied, by estoppel or otherwise, is granted to any intellectual property rights by this document. Skyworks assumes no liability for any materials, products or information provided hereunder, including the sale, distribution, reproduction or use of Skyworks products, information or materials, except as may be provided in Skyworks’ Terms and Conditions of Sale.

THE INFORMATION IN THIS DOCUMENT AND THE MATERIALS AND PRODUCTS DESCRIBED THEREIN ARE PROVIDED “AS IS” WITHOUT WARRANTY OF ANY KIND, WHETHER EXPRESS, IMPLIED, STATUTORY, OR OTHERWISE, INCLUDING FITNESS FOR A PARTICULAR PURPOSE OR USE, MERCHANTABILITY, PERFORMANCE, QUALITY OR NON-INFRINGEMENT OF ANY INTELLECTUAL PROPERTY RIGHT; ALL SUCH WARRANTIES ARE HEREBY EXPRESSLY DISCLAIMED. SKYWORKS DOES NOT WARRANT THE ACCURACY OR COMPLETENESS OF THE INFORMATION, TEXT, GRAPHICS OR OTHER ITEMS CONTAINED WITHIN THESE MATERIALS. SKYWORKS SHALL NOT BE LIABLE FOR ANY DAMAGES, INCLUDING BUT NOT LIMITED TO ANY SPECIAL, INDIRECT, INCIDENTAL, STATUTORY, OR CONSEQUENTIAL DAMAGES, INCLUDING WITHOUT LIMITATION, LOST REVENUES OR LOST PROFITS THAT MAY RESULT FROM THE USE OF THE MATERIALS OR INFORMATION, WHETHER OR NOT THE RECIPIENT OF MATERIALS HAS BEEN ADVISED OF THE POSSIBILITY OF SUCH DAMAGE.

Skyworks products are not designed, intended, authorized, or warranted for use or inclusion in life support or life endangering applications, devices, or systems where failure or inaccuracy might cause death or personal injury. Skyworks customers agree not to use or sell the Skyworks products for such applications, and further agree to, without limitation, fully defend, indemnify, and hold harmless Skyworks and its agents from and against any and all actions, suits, proceedings, costs, expenses, damages, and liabilities including attorneys’ fees arising out of or in connection with such improper use or sale.

Skyworks assumes no liability for applications assistance, customer product design, or damage to any equipment resulting from the use of Skyworks products outside of Skyworks’ published specifications or parameters. Customers are solely responsible for their products and applications using the Skyworks products.

“Skyworks” and the Skyworks Starburst logo are registered trademarks of Skyworks Solutions, Inc., in the United States and other countries. Third-party brands and names are for identification purposes only and are the property of their respective owners. Additional information, including relevant terms and conditions, posted at www.skyworksinc.com, are incorporated by reference.